

DRR244

Controller / Regolatore / régulateur



Introduction

The process controller DRR244 is specifically conceived for application on control panels with DIN rail mounting. It stands out for the bright display which ensures optimal visibility and increased level of information for the operator beside a scrolling help function.

DRR244 relies on Pixsys flagship programming mode by NFC/RFID technology with dedicated App MyPixsys for Android devices (same already used for Pixsys Blue Line controllers, signal converters and STR indicators) not requiring wirings and power supply, allowing quick set-up/updates on site.

The outputs can be selected as command/multiple alarm modes/analogue retransmission. Serial communication RS485 is available with Modbus RTU/Slave protocol. Useful power supply with extended range 24 to 230VAC / VDC with galvanic insulation.

1 Safety guidelines

Read carefully the safety guidelines and programming instructions contained in this manual before connecting/using the device.

Disconnect power supply before proceeding to hardware settings or electrical wirings to avoid risk of electric shock, fire, malfunction.

Do not install/operate the device in environments with flammable/explosive gases.

This device has been designed and conceived for industrial environments and applications that rely on proper safety conditions in accordance with national and international regulations on labour and personal safety. Any application that might lead to serious physical damage/ life risk or involve medical life support devices should be avoided.

Device is not conceived for applications related to nuclear power plants, weapon systems, flight control, mass transportation systems.

Only qualified personnel should be allowed to use device and/or service it and only in accordance to technical data listed in this manual.

Do not dismantle/modify/repair any internal component.

Device must be installed and can operate only within the allowed environmental conditions. Overheating may lead to risk of fire and can shorten the lifecycle of electronic components.

1.1 Organization of safety notices

Safety notices in this manual are organized as follows:

Safety notice	Description
Danger!	Disregarding these safety guidelines and notices can be life-threatening.
Warning!	Disregarding these safety guidelines and notices can result in severe injury or substantial damage to property.
Information!	This information is important for preventing errors.

1.2 Safety Precautions

This product is UL listed as open type process control equipment.	Danger!
If the output relays are used past their life expectancy, contact fusing or burning may occasionally occur.	Danger!
Always consider the application conditions and use the output relays within their rated load and electrical life expectancy. The life expectancy of output relays varies considerably with the output load and switching conditions.	
Loose screws may occasionally result in fire.	Warning!
For screw terminals tighten screws to tightening torque of 0,51 Nm.	Warning!
A malfunction in the Digital Controller may occasionally make control operations impossible or prevent alarm outputs, resulting in property damage. To maintain safety in the event of malfunction of the Digital Controller, take appropriate safety measures, such as installing a monitoring device on a separate line.	

1.3 Precautions for safe use

Be sure to observe the following precautions to prevent operation failure, malfunction, or adverse affects on the performance and functions of the product. Not doing so may occasionally result in unexpected events. Do not handle the Digital Controller in ways that exceed the ratings.

- The product is designed for indoor use only. Do not use or store the product outdoors or in any of the following places.
 - Places directly subject to heat radiated from heating equipment.
 - Places subject to splashing liquid or oil atmosphere.
 - Places subject to direct sunlight.
 - Places subject to dust or corrosive gas (in particular, sulfide gas and ammonia gas).
 - Places subject to intense temperature change.
 - Places subject to icing and condensation.
 - Places subject to vibration and large shocks.
- Installing two or more controllers in close proximity might lead to increased internal temperature and this might shorten the life cycle of electronic components. It is strongly recommended to install cooling fans or other air-conditioning devices inside the control cabinet.
- Always check the terminal names and polarity and be sure to wire properly. Do not wire the terminals that are not used.
- To avoid inductive noise, keep the controller wiring away from power cables that carry high voltages or large currents. Also, do not wire power lines together with or parallel to Digital Controller wiring. Using shielded cables and using separate conduits or ducts is recommended. Attach a surge suppressor or noise filter to peripheral devices that generate noise (in particular motors, transformers, solenoids, magnetic coils or other equipment that have an inductance component). When a noise filter is used at the power supply, first check the voltage or current, and attach the noise filter as close as possible to the Digital Controller. Allow as much space as possible between the Digital Controller and devices that generate powerful high frequencies (high-frequency welders, high-frequency sewing machines, etc.) or surge.
- A switch or circuit breaker must be provided close to device. The switch or circuit breaker must be within easy reach of the operator, and must be marked as a disconnecting means for the controller.
- The device must be protected by a fuse 1A (cl. 9.6.2).
- Wipe off any dirt from the Digital Controller with a soft dry cloth. Never use thinners, benzine, alcohol, or any cleaners that contain these or other organic solvents. Deformation or discoloration may occur.
- The number of non-volatile memory write operations is limited. Therefore, use EEprom write mode when frequently overwriting data, e.g.: through communications.

1.4 Environmental policy / WEEE

Do not dispose electric tools together with household waste material.

According to European Directive 2002/96EC on waste electrical and electronic equipment and its implementation in accordance with national law, electric tools that have reached the end of their life must be collected separately and returned to an environmentally compatible recycling facility.

2 Model Identification

The DRR244 controller provides the following model:

Power supply 24...230 VAC/VDC $\pm 15\%$ 50/60 Hz – 9 Watt/VA

DRR244-13ABC-T	1 analogue input + 2 relays 5 A + 1 relay 2 A + 2 SSR + 2 D.I. + 1 analogue output V/mA + RS485 + CT
----------------	--

3 Technical Data

3.1 General Features

Displays	4 digits 0,52", 5 digits 0,30"
Operating temperature	Temperature: 0-45° C -Humidity 35..95 uR% Max. altitude: 2000m
Sealing	IP20 box
Material	Box: Polycarbonate self-extinguishing; Front panel: Polyamide self-extinguishing
Weight	Approx. 210 g

3.2 Hardware Features

Analogue inputs	AI1 Configurable via software. Input: Thermocouple type K, S, R, J,T,E,N,B. Automatic compensation of cold junction from -25..85° C. Thermoresistances: PT100, PT500, PT1000, Ni100, PTC 1K, NTC 10K (β 3435K) Input V/mA: 0-1 V, 0-5 V, 0-10 V, 0-20 o 4-20 mA, 0-60 mV. Pot. Input: 1...150 K Ω . CT: 50 mA.	Tolerance (25° C) $\pm 0.2\% \pm 1$ digit (on F.s.) for thermocouple, thermoresistance and V/mA. Cold junction accuracy 0.1° C/°C. Impedence: 0-10 V: Ri>110 K Ω 0-20 mA: Ri<5 Ω 0-40 mV: Ri>1 M Ω
Relay outputs	Configurable as command and alarm output.	Contacts: Q1, Q2: 5 A - 250 VAC for resistive load. Q3: 2 A - 250 VAC for resistive load.
SSR outputs	Configurable as command and alarm output.	12/24 V, 25 mA.
Analogue output	Configurable as command and alarm output or as retrasmision of process / setpoints.	Configurable: 0-10 V with 40000 points +/-0.2% (on F.s.) 4-20 mA con 40000 points +/-0.2% (on F.s.)
Power-supply	Extended power-supply 24..230 VAC/ VDC $\pm 15\%$ 50/60 Hz	Consumption: 9 Watt/VA

3.3 Software Features

Regulation algorithms	ON-OFF with hysteresis. P, PI, PID, PD with proportional time
Proportional band	0..9999°C o °F
Integral time	0,0..999,9 sec (0 excludes)
Derivative time	0,0..999,9 sec (0 excludes)
Controller functions	Manual or automatic Tuning, selectable alarm, protection of command and alarm setpoints.

3.4 Programming mode

by keyboard	..see paragraph 9
software LabSoftview	..on "Download section" of official pixsys site: www.pixsys.net
App MyPixsys	..through download the App on Google Play Store®, see paragraph 8 When activated by a reader/interrogator supporting NFC-V protocol, controller DRR244 is to be considered a VICC (Vicinity Inductively Coupled Card) according to ISO/IEC 15693 and it operates at a frequency of 13.56 MHz. The device does not intentionally emit radio waves.

4 Dimensions and Installation

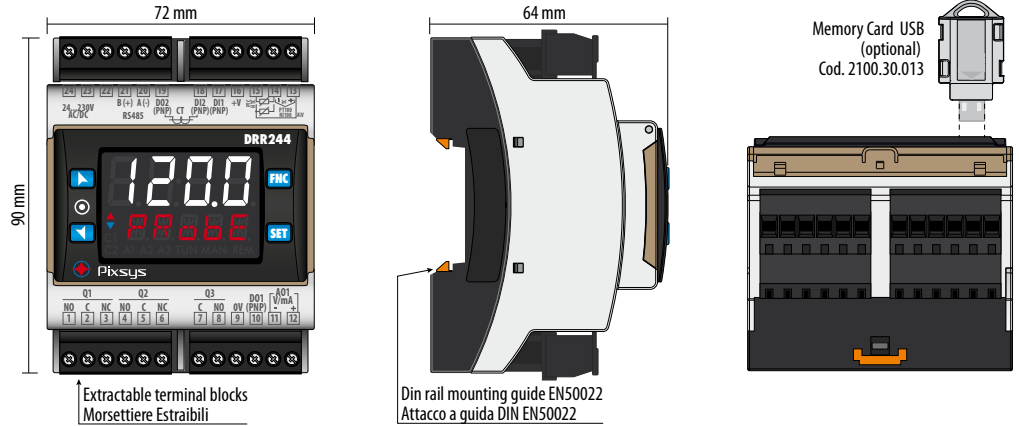

5 Electrical wirings

This controller has been designed and manufactured in conformity to Low Voltage Directive 2006/95/EC, 2014/35/EU (LVD) and EMC Directive 2004/108/EC, 2014/30/EU (EMC). For installation in industrial environments please observe following safety guidelines:

- Separate control line from power wires.
- Avoid proximity of remote control switches, electromagnetic contactors, powerful engines.
- Avoid proximity of power groups, especially those with phase control.
- It is strongly recommended to install adequate mains filter on power supply of the machine where the controller is installed, particularly if supplied 230Vac.

The controller is designed and conceived to be incorporated into other machines, therefore CE marking on the controller does not exempt the manufacturer of machines from safety and conformity requirements applying to the machine itself.

- Wiring of pins: use crimped tube terminals or flexible/rigid copper wire with diameter 0.2 to 2.5 mm² (min. AWG28, max. AWG12, operating temperature: min. 70°C). Cable stripping length 7 to 8 mm.

5.1 Wiring diagram

DRR244-13ABC-T

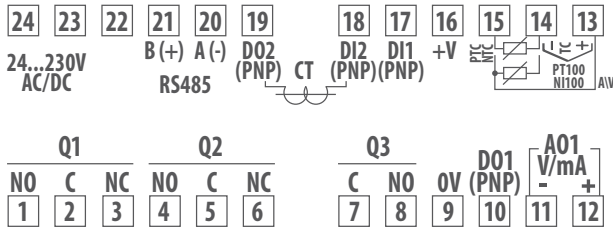

5.1.a Power Supply

<p>24 23 SUPPLY 24...230 VAC/DC</p>	<p>Switching power supply 24..230 VAC/VDC $\pm 15\%$ 50/60 Hz - 9 Watt/VA. Galvanic insulation (2500V).</p>
--	--

5.1.b Analogue Input AI1

	<p>For thermocouples K, S, R, J, T, E, N, B.</p> <ul style="list-style-type: none"> Comply with polarity For possible extensions, use compensated cable and terminals suitable for the thermocouples used (compensated). When shielded cable is used, it should be grounded at one side only.
	<p>For thermoresistances PT100, Ni100.</p> <ul style="list-style-type: none"> For the three-wire connection use wires with the same section. For the two-wire connection short-circuit terminals 13 and 15 When shielded cable is used, it should be grounded at one side only. <div style="text-align: center;"> </div>
	<p>For thermoresistances NTC, PTC, PT500, PT1000 and linear potentiometers.</p> <p>When shielded cable is used, it should be grounded at one side only to avoid ground loop currents.</p>
	<p>For linear signals in Volt and mA</p> <ul style="list-style-type: none"> Comply with polarity When shielded cable is used, it should be grounded at one side only to avoid ground loop currents. It's possible to select +V at 12Vdc or 24Vdc, by configuring parameter 282 u.o.u.t (GROUP R - d iSP - Display and interface).

5.1.c CT input

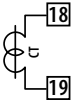

To enable CT input, modify parameter 287 $c\pm F$.

- Input for 50 mA amperometric transformer.
- Sampling time 100 ms.
- Configurable by parameters.

5.1.d Digital inputs



Digital inputs can be enabled by parameters.

Close pin "Dix" on pin "+V" to enable digital input.

It is possible to put in parallel the digital inputs of different devices joining together the 0V pins (9).

5.1.e Serial input

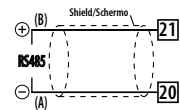

Modbus RS485 communication.
RTU Slave with galvanic insulation.

It is recommended to use the twisted and shielded cable for communications.

5.1.f Digital output

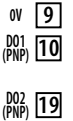

Digital output PNP (including SSR) for command or alarm.
Range 12 VDC/25 mA or 24 VDC/15mA selectable by parameter 282 $u.o.out$.

5.1.g Analogue output AO1



Linear output in mA or V (galvanically isolated) configurable as command, alarm or retransmission of process-setpoint.

The selection mA or Volt for the linear output depends on the parameters configuration.

5.1.h Relays output Q1 - Q2

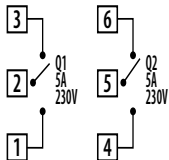

Capacity 5 A / 250 VAC for resistive loads.
See chart below.

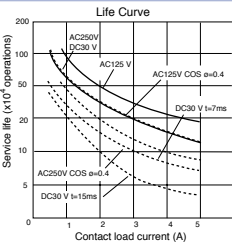

Electrical endurance Q1, Q2:

- 5A, 250 VAC, resistive loads, 10⁵ operations.
- 20/2A, 250 VAC, $\cos\phi = 0.3$, 10⁵ operations.

5.1.i Relay output Q3



Capacity 2 A / 250 VAC for resistive loads.
See chart below.

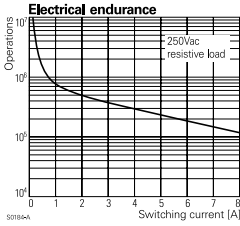

Electrical endurance Q3:

- 2A, 250 VAC, resistive loads, 10^5 operations.
- 20/2A, 250 VAC, $\cos\phi = 0.3$, 10^5 operations.

6 Display and Key Functions

	1	234	Normally displays the process. During the configuration phase, it displays the parameter being inserted.
	2	Probe	Normally displays the setpoint. During the configuration phase, it displays the parameter value being inserted.

6.1 Meaning of Status Lights (Led)

3	C1	ON when the command output 1 is active. In versions with single analog input, it is ON when the valve is opening. In the versions with two analog inputs, in case of command 1 on the motorized valve, it is permanently ON when the valve is opening and flashing during the closing phase.
4	C2	ON when the command output 2 is active. In versions with single analog input, it is ON when the valve is opening. In the versions with two analog inputs, in case of command 2 on the motorized valve, it is permanently ON when the valve is opening and flashing during the closing phase.
5	A1	ON when alarm 1 is active.
6	A2	ON when alarm 2 is active.
7	A3	ON when alarm 3 is active.
8	TUN	ON when the controller is executing an auto-tuning cycle.
9	MAN	ON when "Manual" function is active.
10	REM	ON when the controller communicates through serial. Flashes when the remote setpoint is enabled.